



www.brightoncabinetry.com

CATALOG VERSION

BR1803

20/20 Version BR1803 (A/B)

Residential Interior Contents

<p>ACCESSORIES AND MODIFICATIONS..... 27</p> <p style="padding-left: 20px;">BASE MINI FILLER..... 27</p> <p style="padding-left: 20px;">BASE MINI OVERLAY FILLER..... 27</p> <p style="padding-left: 20px;">PLANNING DESK LEG..... 6</p> <p>BASE MINI CABINETS</p> <p style="padding-left: 20px;">1 DRAWER, 1 DOOR CABINET..... 3</p> <p style="padding-left: 20px;">2 DRAWER 1 DOOR CABINET..... 3</p> <p style="padding-left: 20px;">2 DRAWER CABINET..... 4</p> <p style="padding-left: 20px;">3 DRAWER CABINET..... 5</p> <p style="padding-left: 20px;">FULL HEIGHT DOOR CABINET..... 2</p> <p>BOOKCASES</p> <p style="padding-left: 20px;">BASE BOOKCASE 8</p> <p style="padding-left: 20px;">COUNTERTOP BOOKCASE 10</p> <p style="padding-left: 20px;">TALL BOOKCASE 11-16</p> <p style="padding-left: 20px;">TALL DIAGONAL BOOKCASE..... 17</p> <p style="padding-left: 20px;">VERTICAL STACK BOOKCASE..... 10A</p> <p style="padding-left: 20px;">WALL BOOKCASE 9</p> <p>DRESSER, 4 DRAWER..... 21</p> <p>FILE CABINETS</p> <p style="padding-left: 20px;">3 DRAWER FILE CABINET..... 7</p> <p style="padding-left: 20px;">4 DRAWER FILE CABINET..... 7</p> <p style="padding-left: 20px;">MINI 2 DRAWER FILE CABINET..... 4</p> <p style="padding-left: 20px;">MINI 3 DRAWER w/ FILE CABINET..... 5</p>	<p>FIREPLACE SURROUND</p> <p style="padding-left: 20px;">CORNER FIREPLACE..... 26</p> <p style="padding-left: 20px;">FLAT FIREPLACE WITH APPLIQUE..... 25</p> <p style="padding-left: 20px;">FLAT FIREPLACE WITHOUT APPLIQUE.. 25</p> <p>HUTCH..... 24</p> <p>KEYPAD DRAWER, MINI..... 6</p> <p>MANTLE SHELF..... 24</p> <p>NIGHT STANDS 22</p> <p>PLANNING DESK, MINI 6</p> <p>WINDOW SEATS</p> <p style="padding-left: 20px;">1 DRAWER SEAT..... 23</p> <p style="padding-left: 20px;">2 DRAWER SEAT..... 23</p> <p style="padding-left: 20px;">FULL HEIGHT DOOR SEAT..... 23</p> <p style="padding-left: 20px;">OPEN SEAT..... 23</p>
--	---

BASE MINI FULL HEIGHT DOOR(S), 29" HIGH

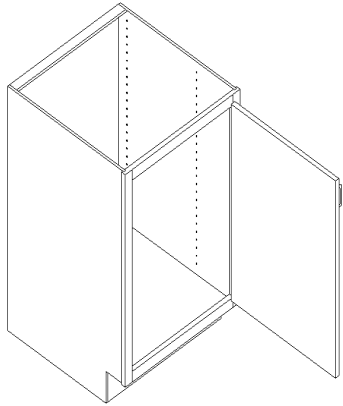

BMFD, single door

- Two full depth adjustable shelves in 21" deep cabinet
- Two 3/4 depth adjustable shelves in 24" deep cabinet
- Single door, specify left (L) or right (R) for hinge side

	PRODUCT CODE	LEVEL 1	LEVEL 2
21" deep	BMFD1221		
	BMFD1521		
	BMFD1821		
	BMFD2121		
	BMFD2421-1		

24" deep	BMFD1224		
	BMFD1524		
	BMFD1824		
	BMFD2124		
	BMFD2424-1		

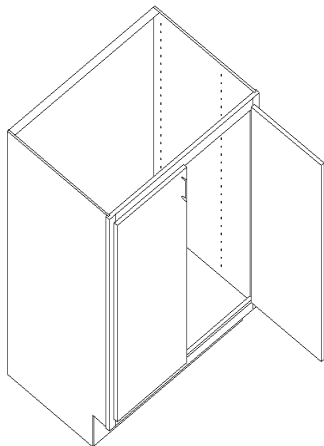

BMFD, two doors

- Two full depth adjustable shelves in 21" deep cabinet
- Two 3/4 depth adjustable shelves in 24" deep cabinet

	Two Doors		
21" deep	BMFD2421-2		
24" deep	BMFD2424-2		

BASE MINI 1 DRAWER, 1 DOOR, 29" HIGH



	PRODUCT CODE	LEVEL 1	LEVEL 2
21" deep	BM1221		
	BM1521		
	BM1821		
	BM2121		
	BM2421-1		
24" deep	BM1224		
	BM1524		
	BM1824		
	BM2124		
	BM2424-1		

- Top drawers full overlay height equals 5 3/4", semi overlay height equals 5".
- One adjustable shelf
- 3" high pencil drawer.
- 5 piece drawer fronts available in full overlay only. Not available with Hanover door style.

BASE MINI 2 DRAWER, 1 DOOR, 29" HIGH

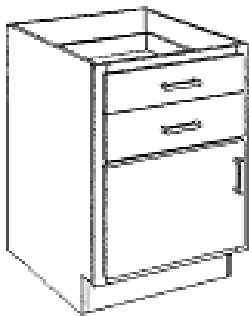

	PRODUCT CODE	LEVEL 1	LEVEL 2
21" deep	BM2D1221		
	BM2D1521		
	BM2D1821		
	BM2D2121		
	BM2D2421-1		
24" deep	BM2D1224		
	BM2D1524		
	BM2D1824		
	BM2D2124		
	BM2D2424-1		

- Top drawers full overlay height equals 5 3/4", semi overlay height equals 5".
- No adjustable shelf.
- Two 3" high pencil drawers.
- 5 piece drawer fronts available in full overlay only. Not available with Hanover door style.

BASE MINI 2 DRAWER FILE, 29" HIGH

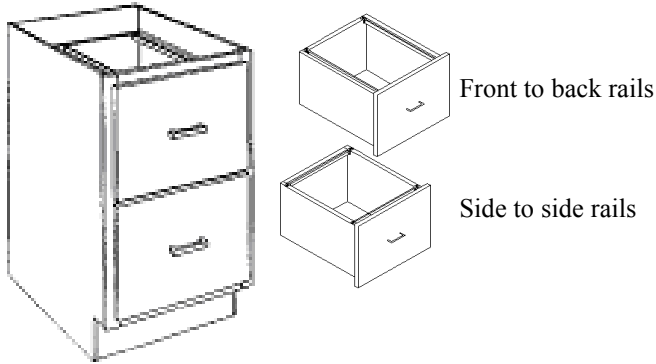

	PRODUCT CODE	LEVEL 1	LEVEL 2
21" deep	BM2DF15		
	BM2DF18		
	BM2DF21		
	BM2DF24		
24" deep	BM2DF15		
	BM2DF18		
	BM2DF21		
	BM2DF24		

- Both drawers are 10" high and accommodate hanging files with low profile tabs.
- 130# undermount full extension glides are standard on all file drawers.
- Height cannot be reduced.
- All top to bottom drawer front reveals will be 1/4", side reveals will be same as ordered.
- All cabinet will accept letter size files. Specify when wanting to use for legal files. (BM2DF1521, BM2DF1821 will not accept legal files.)

Standard guidelines for file rail direction:

Cabinets with a frame opening of less than 15" wide will have file rails that run side to side. Cabinets with a 15" wide frame opening or greater will have file rails that run front to back. Specify direction of file rails only if different from standard. (15" wide cabinets cannot accept front to back file rails.)

BASE MINI 2 DRAWER BASE, 29" HIGH

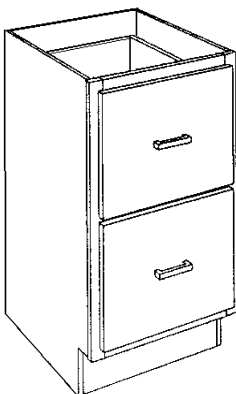

	PRODUCT CODE	LEVEL 1	LEVEL 2
21" deep	BM2ED1221		
	BM2ED1521		
	BM2ED1821		
	BM2ED2121		
	BM2ED2421		
24" deep	BM2ED1224		
	BM2ED1524		
	BM2ED1824		
	BM2ED2124		
	BM2ED2424		

- Two equal height drawer fronts.
- Two 8" high drawer boxes
- Will not accommodate hanging file folders.

BASE MINI THREE DRAWER, 29" HIGH

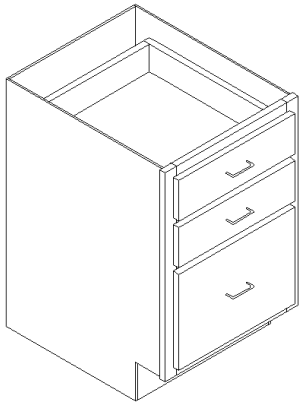

Note for 2 top drawers: 5 piece drawer fronts available in full overlay only. Not available with Hanover door style.

PRODUCT LEVEL 1 LEVEL 2
CODE

21" deep	BM3D1221
	BM3D1521
	BM3D1821
	BM3D2121
	BM3D2421
24" deep	BM3D1224
	BM3D1524
	BM3D1824
	BM3D2124
	BM3D2424

- 2-3" high pencil drawers at top.
- 2 top drawer fronts: full overlay height equals 5 3/4", semi overlay height equals 5".
- Bottom drawer will accept letter size files (not available for Inset) but hanging file rails are not included with this cabinet. To order see BM3DF or base accessories.

BASE MINI THREE DRAWER w/ FILE, 29" HIGH

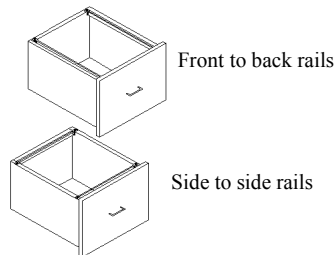
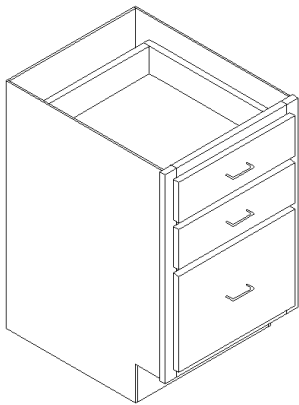

Note for two top drawers: 5 piece drawer fronts available in full overlay only. Not available with Hanover door style.

21" deep	BM3DF1221
	BM3DF1521
	BM3DF1821
	BM3DF2121
	BM3DF2421
24" deep	BM3DF1224
	BM3DF1524
	BM3DF1824
	BM3DF2124
	BM3DF2424

- Not available for Inset.
- Height cannot be reduced.
- Two 3" high pencil drawers at top.
- Two top drawer fronts: full overlay height equals 5 3/4", semi overlay height equals 5".
- Bottom drawer will accept letter size files. Specify when wanting to use for legal files. (BM3DF1221, BM3DF1521, BM3DF1821 will not accept legal files.)
- 12" and 15" wide cabinets will have file system side to side. 18" wide or wider cabinets will accept file system front to back.
- 130# undermount full extension glides are standard on all file drawers.

Standard guidelines for file rail direction:

Cabinets with a frame opening of less than 15" wide will have file rails that run side to side. Cabinets with a 15" wide frame opening or greater will have file rails that run front to back. Specify direction of file rails only if different from standard. (12" and 15" wide cabinets cannot accept front to back file rails.)

PLANNING DESK MINI

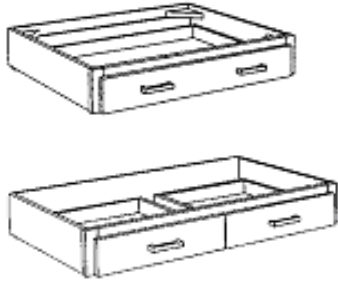

- Standard height is 4 5/8" overall (1 1/4" top rail, no bottom rail).
- Specify height if aligning with other cabinets. (Add increase height modification from base section.)
- 2" high drawer box.
- Cannot be reduced in height.
- Slab drawer fronts are the only drawer fronts available.

	PRODUCT CODE	LEVEL 1	LEVEL 2
One drawer	PDM1D2421		
	PDM1D2721		
	PDM1D3021		
	PDM1D3321		
	PDM1D3621		
	PDM1D2424		
	PDM1D2724		
	PDM1D3024		
	PDM1D3324		
	PDM1D3624		
Two drawer	PDM2D3321		
	PDM2D3621		
	PDM2D3324		
	PDM2D3624		

SLIDE OUT KEYPAD DRAWERS MINI

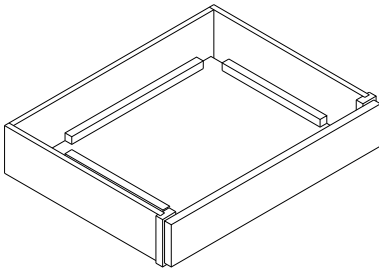

- Slide out keypad tray.
- Standard height is 4 5/8" overall. (1 1/4" bottom rail, no top rail)
- Specify height if aligning with other cabinets, add increase height modification from base section.
- Fold down drawer front.
- Cannot be reduced in height.
- Slab drawer fronts are the only drawer fronts available.
- Single drawer only.
- Back and side fence rails attached to top of keypad tray.

21" deep	KPDM2421		
	KPDM2721		
	KPDM3021		
	KPDM3321		
24" deep	KPDM2424		
	KPDM2724		
	KPDM3024		
	KPDM3324		

PLANNING DESK MINI LEGS

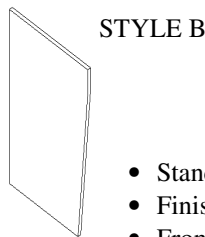
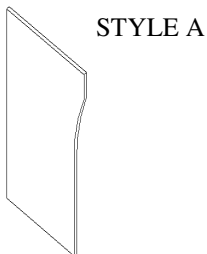

- Standard is 29" high, 21" or 24" deep.
- Finished on both sides and face edge.
- Front flat will equal height of Mini Planning Desk.

PDLMA21		
PDLMA24		
PDLMB21		
PDLMB24		

BASE 3 DRAWER FILE, 45 3/4" HIGH

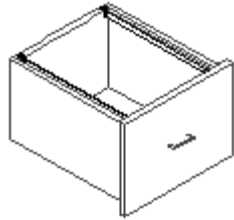
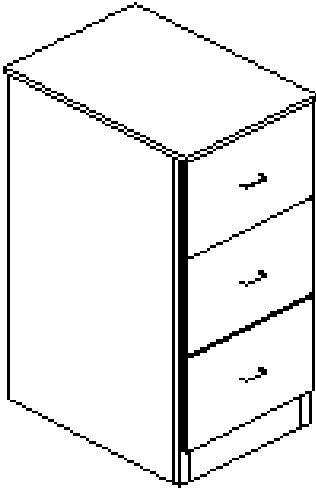

Front to back rails

PRODUCT CODE	LEVEL 1	LEVEL 2
--------------	---------	---------

24" deep B3DF1845.75

THREE DRAWER FILE CABINET

- 3/4" applied top with machine edge standard.
- Finished sides are standard.
- Flush toe base.
- All drawers are 10" high and accommodate hanging files, front to back.
- 130# undermount full extension glides are standard on all file drawers.
- This unit must be secured to wall to prevent it from tipping.
- This cabinet will accept letter size files only.
- All top to bottom drawer front reveals will be 1/4", side reveals will be same as ordered.

BASE 4 DRAWER FILE, 58 3/4" HIGH

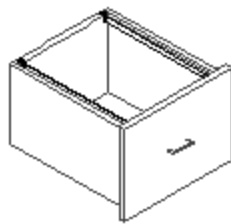
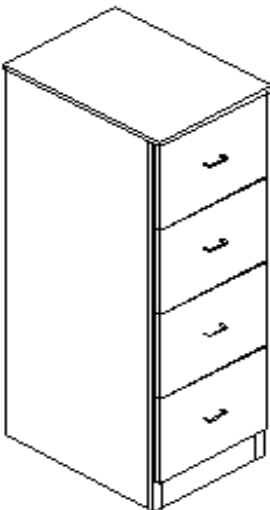

Front to back rails

PRODUCT CODE	LEVEL 1	LEVEL 2
--------------	---------	---------

24" deep B4DF1858.75

FOUR DRAWER FILE CABINET

- 3/4" applied top with machine edge standard.
- Finished sides are standard.
- Flush toe base.
- All drawers are 10" high and accommodate hanging files, front to back.
- 130# undermount full extension glides are standard on all file drawers.
- This unit must be secured to wall to prevent it from tipping.
- This cabinet will accept letter size files only.
- All top to bottom reveals will be 1/4", side reveals will be same as ordered

BOOKCASES

All bookcases are 13” deep, with finished interiors as standard unless specifically noted. They are made from plywood veneers with solid wood face frames made of the same specie. Bookcases are standard with a straight, 5” top frame rail (6” for Inset orders) or valance top rails can be added at no additional charge for most designs. See Wall section for valance types or send drawing for custom valance. Bookcase shelves will all be made of 3/4” plywood with 1 1/2” frame stock attached to the front edge of the shelf. The frame stock will be flush with the top edge of the adjustable shelves. The entire shelf will then be behind the face frame of the cabinet. Desired finished end options must be selected when needed as all ends are built unfinished as standard.

Wall bookcases from 30” to 48” tall are wall cabinets that have had their doors removed and interiors finished with valance top rail.

Countertop bookcases are designed to rest on the countertop when installed. They do not have a bottom face frame rail or a floor. They are built with a shipping brace across the lower, front edge that is to be removed before installation.

Base bookcases are really no more than wall bookcases with flush toe kicks added.

Tall bookcases are built with a face frame rail installed at 34 1/2” above the floor. Standard full height base doors can be fitted to this opening. Additionally they are made with a flush toe bottom frame rail. All tall bookcases over 84” high come with a full height frame (including the flush toe) that must be tipped up from the back to stand in the room. They also ship with the sub-toe platform unattached. The sub-toe must be slid into position when the cabinet is in its installation spot. Finished ends must also be considered when ordering bookcases over 84” tall. The sub-toe sides are not finished at the factory. A finished covering must be applied in the field to the sides of the toe area when it will be exposed. The sub-toe can be integrated at the factory by request for no additional charge using the MINTTK modification. Contact Customer Service for other possible options.

See Wall, Tall, or Base sections for modifications and applicable pricing.

When ordering bookcases, please specify top rail valance type; straight valance is standard.

BASE BOOKCASE UNIT

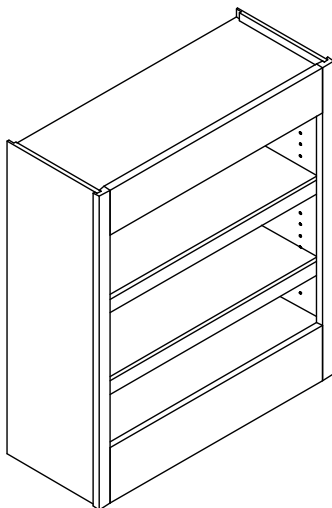

PRODUCT CODE	LIST
BBU15	
BBU18	
BBU21	
BBU24	
BBU27	
BBU30	
BBU33	
BBU36	

- 13” deep, 34 1/2” high standard
- Two 3/4” adjustable shelves with 1 1/2” frame stock front edge
- Straight valance top rail, specify if other valance design is desired (no upcharge).
- Bottom rail with flush toe is 6” wide.

WALL BOOKCASE UNIT, 13" DEEP

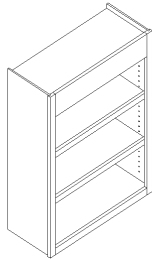

Two 3/4" adjustable shelves with 1 1/2" frame stock front edge.
 Straight valance top rail, specify if other valance design is desired (no upcharge).

	PRODUCT CODE	LIST
30" tall	WBU1530	
	WBU1830	
	WBU2130	
	WBU2430	
	WBU2730	
	WBU3030	
	WBU3330	
	WBU3630	

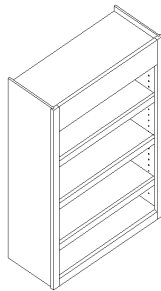

Two 3/4" adjustable shelves with 1 1/2" frame stock front edge.
 Straight valance top rail, specify if other valance design is desired (no upcharge).

36" tall	WBU1536	
	WBU1836	
	WBU2136	
	WBU2436	
	WBU2736	
	WBU3036	
	WBU3336	
	WBU3636	

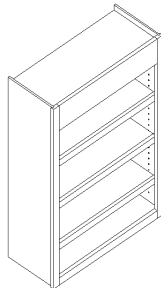

Three 3/4" adjustable shelves with 1 1/2" frame stock front edge.
 Straight valance top rail, specify if other valance design is desired (no upcharge).

42" tall	WBU1542	
	WBU1842	
	WBU2142	
	WBU2442	
	WBU2742	
	WBU3042	
	WBU3342	
	WBU3642	

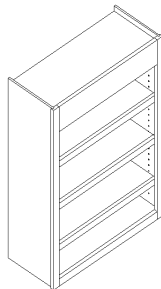

Three 3/4" adjustable shelves with 1 1/2" frame stock front edge.
 Straight valance top rail, specify if other valance design is desired (no upcharge).

48" tall	WBU1548	
	WBU1848	
	WBU2148	
	WBU2448	
	WBU2748	
	WBU3048	
	WBU3348	
	WBU3648	

COUNTER TOP BOOKCASE UNITS, 13" DEEP

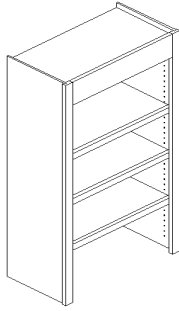

	PRODUCT CODE	LIST
48" tall	CTBU1848	
	CTBU2148	
	CTBU2448	
	CTBU2748	
	CTBU3048	
	CTBU3348	
	CTBU3648	

Three 3/4" adjustable shelves with 1 1/2" frame stock front edge.
Straight valance top rail, specify if other valance design is desired (no upcharge).

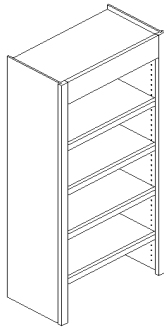

54" tall	CTBU1854	
	CTBU2154	
	CTBU2454	
	CTBU2754	
	CTBU3054	
	CTBU3354	
	CTBU3654	

Four 3/4" adjustable shelves with 1 1/2" frame stock front edge.
Straight valance top rail, specify if other valance design is desired (no upcharge).

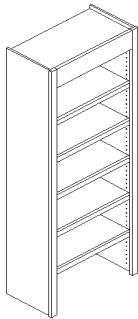

60" tall	CTBU1860	
	CTBU2160	
	CTBU2460	
	CTBU2760	
	CTBU3060	
	CTBU3360	

Five 3/4" adjustable shelves with 1 1/2" frame stock front edge.
Straight valance top rail, specify if other valance design is desired (no upcharge).

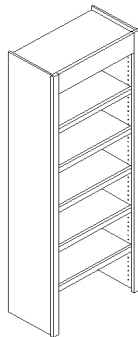

66" tall	CTBU1866	
	CTBU2166	
	CTBU2466	
	CTBU2766	
	CTBU3066	
	CTBU3366	

Five 3/4" adjustable shelves with 1 1/2" frame stock front edge.
Straight valance top rail, specify if other valance design is desired (no upcharge).

VERTICAL STACK BOOKCASE UNITS, 13" DEEP

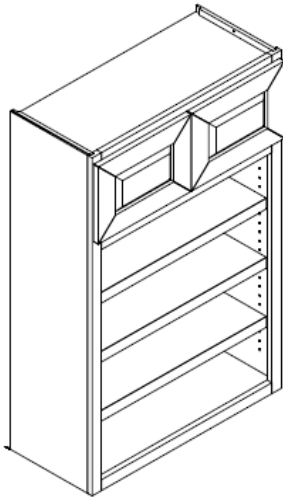

WBU12VS3048 shown

- 13" deep, standard
- Wall cabinet with the look of two cabinets that have been stacked one on top of the other.
- Two frame openings, one top and one bottom with a center frame rail and fixed center floor dividing the two sections.
- Offered with top doors only equal to 12", 15", 18" or 21" high cabinets. Upper door heights will align with cabinet height that is equal to the first set of numbers listed in the nomenclature. See page W12 in the Wall Section for more details.
- Lower section is open (no doors) with matching wood interior throughout the entire cabinet as standard.
- Lower openings tall enough for shelves will have 3/4" adjustable shelves with 1 1/2" frame stock front edge.
- "Single door" indicates one door across width for each opening. "Two doors" indicates 2 butt-doors for each opening. Butt-door version pictured.
- Specify L or R for hinge side when applicable.
- Any height change will modify the cabinet in the lower section. The upper frame opening height will not change unless specified on the order and will require a frame change charge (MFC).
- FOL-C overlay cabinet has a 3" face frame mid-rail. All other overlays have a 1 1/2" face frame mid-rail.
- Cabinets 39" wide or greater will have a fixed center stile in both sections as standard.
- Add MOBREF, omit bottom rail and floor modification, for a vertical stacked CTBU look.

	PRODUCT CODE	LEVEL 1	LEVEL 2
48" tall	WBU_VS1848		
	WBU_VS2148		
	WBU_VS2448		
	WBU_VS2448-2		
	WBU_VS2748		
	WBU_VS3048		
	WBU_VS3348		
	WBU_VS3648		
54" tall	WBU_VS1854		
	WBU_VS2154		
	WBU_VS2454		
	WBU_VS2454-2		
	WBU_VS2754		
	WBU_VS3054		
	WBU_VS3354		
	WBU_VS3654		
60" tall	WBU_VS1860		
	WBU_VS2160		
	WBU_VS2460		
	WBU_VS2460-2		
	WBU_VS2760		
	WBU_VS3060		
	WBU_VS3360		
	WBU_VS3660		
66" tall	WBU_VS1866		
	WBU_VS2166		
	WBU_VS2466		
	WBU_VS2466-2		
	WBU_VS2766		
	WBU_VS3066		
	WBU_VS3366		
	WBU_VS3666		



NOTES

TALL BOOKCASE UNITS, 13" DEEP

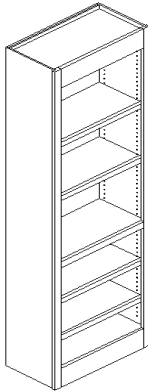

- Bookcases up to 85" tall will have 2 shelves in the upper and 2 shelves in the lower. They are 3/4" adjustable shelves with 1 1/2" frame stock front edge.
- One fixed shelf and center rail at 34 1/2" above floor.
- Finish interior
- Flush toe kick bottom rail
- Straight valance top rail, specify if other valance design is desired (no upcharge).
- 84" tall ships as illustrated with flush toe and integrated sub-toe. (Any over 84" tall ships with flush toe and loose sub-toe platform. A finished covering must be applied in the field to the sides of the toe area when it will be exposed.)

	PRODUCT LIST CODE
84" tall	TBU188413
	TBU218413
	TBU248413
	TBU278413
	TBU308413
	TBU338413
	TBU368413

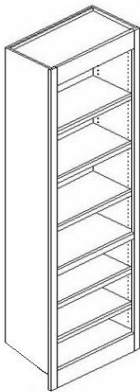

- Bookcases over 85" and up to 91" tall will have 3 shelves in the upper and 2 shelves in the lower. They are 3/4" adjustable shelves with 1 1/2" frame stock front edge.
- One fixed shelf and center rail at 34 1/2" above floor.
- Finish interior
- Flush toe kick bottom rail
- Straight valance top rail, specify if other valance design is desired (no upcharge).
- 90" tall ships as illustrated with flush toe and loose sub-toe platform. A finished covering must be applied in the field to the sides of the toe area when it will be exposed.

90" tall	TBU189013
	TBU219013
	TBU249013
	TBU279013
	TBU309013
	TBU339013
	TBU369013

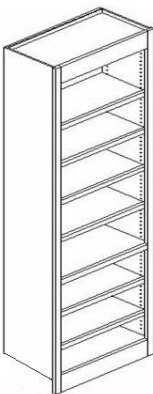

- Bookcases over 91" and up to 97" tall will have 4 shelves in the upper and 2 shelves in the lower. They are 3/4" adjustable shelves with 1 1/2" frame stock front edge.
- One fixed shelf and center rail at 34 1/2" above floor.
- Finish interior
- Flush toe kick bottom rail
- Straight valance top rail, specify if other valance design is desired (no upcharge).
- 96" tall ships as illustrated with flush toe and loose sub-toe platform. A finished covering must be applied in the field to the sides of the toe area when it will be exposed.

96" tall	TBU189613
	TBU219613
	TBU249613
	TBU279613
	TBU309613
	TBU339613
	TBU369613

TALL BOOKCASE UNITS, 16" DEEP

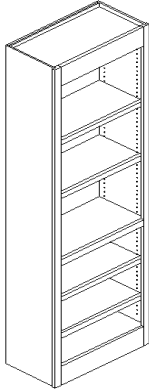

- Bookcases up to 85" tall will have 2 shelves in the upper and 2 shelves in the lower. They are 3/4" adjustable shelves with 1 1/2" frame stock front edge.
- One fixed shelf and center rail at 34 1/2" above floor.
- Finish interior
- Flush toe kick bottom rail
- Straight valance top rail, specify if other valance design is desired (no upcharge).
- 84" tall ships as illustrated with flush toe and integrated sub-toe. (Any over 84" tall ships with flush toe and loose sub-toe platform. A finished covering must be applied in the field to the sides of the toe area when it will be exposed.)

	PRODUCT LIST CODE
84" tall	TBU188416
	TBU218416
	TBU248416
	TBU278416
	TBU308416
	TBU338416
	TBU368416

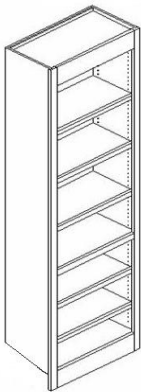

- Bookcases over 85" and up to 91" tall will have 3 shelves in the upper and 2 shelves in the lower. They are 3/4" adjustable shelves with 1 1/2" frame stock front edge.
- One fixed shelf and center rail at 34 1/2" above floor.
- Finish interior
- Flush toe kick bottom rail
- Straight valance top rail, specify if other valance design is desired (no upcharge).
- 90" tall ships as illustrated with flush toe and loose sub-toe platform. A finished covering must be applied in the field to the sides of the toe area when it will be exposed.

90" tall	TBU189016
	TBU219016
	TBU249016
	TBU279016
	TBU309016
	TBU339016
	TBU369016

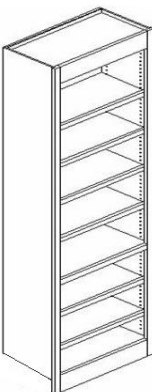

- Bookcases over 91" and up to 97" tall will have 4 shelves in the upper and 2 shelves in the lower. They are 3/4" adjustable shelves with 1 1/2" frame stock front edge.
- One fixed shelf and center rail at 34 1/2" above floor.
- Finish interior
- Flush toe kick bottom rail
- Straight valance top rail, specify if other valance design is desired (no upcharge).
- 96" tall ships as illustrated with flush toe and loose sub-toe platform. A finished covering must be applied in the field to the sides of the toe area when it will be exposed.

96" tall	TBU189616
	TBU219616
	TBU249616
	TBU279616
	TBU309616
	TBU339616
	TBU369616

TALL BOOKCASE UNITS, 18" DEEP

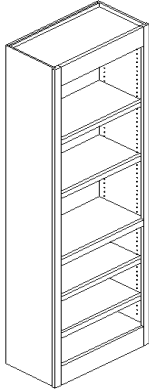

- Bookcases up to 85" tall will have 2 shelves in the upper and 2 shelves in the lower. They are 3/4" adjustable shelves with 1 1/2" frame stock front edge.
- One fixed shelf and center rail at 34 1/2" above floor.
- Finish interior
- Flush toe kick bottom rail
- Straight valance top rail, specify if other valance design is desired (no upcharge).
- 84" tall ships as illustrated with flush toe and integrated sub-toe. (Any over 84" tall ships with flush toe and loose sub-toe platform. A finished covering must be applied in the field to the sides of the toe area when it will be exposed.)

	PRODUCT CODE	LIST
84" tall	TBU188418	
	TBU218418	
	TBU248418	
	TBU278418	
	TBU308418	
	TBU338418	
	TBU368418	

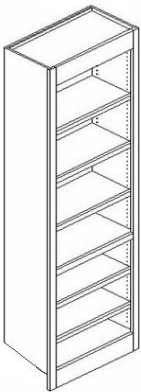

- Bookcases over 85" and up to 91" tall will have 3 shelves in the upper and 2 shelves in the lower. They are 3/4" adjustable shelves with 1 1/2" frame stock front edge.
- One fixed shelf and center rail at 34 1/2" above floor.
- Finish interior
- Flush toe kick bottom rail
- Straight valance top rail, specify if other valance design is desired (no upcharge).
- 90" tall ships as illustrated with flush toe and loose sub-toe platform. A finished covering must be applied in the field to the sides of the toe area when it will be exposed.

90" tall	TBU189018	
	TBU219018	
	TBU249018	
	TBU279018	
	TBU309018	
	TBU339018	
	TBU369018	

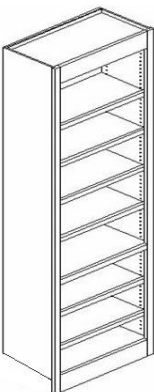

- Bookcases over 91" and up to 97" tall will have 4 shelves in the upper and 2 shelves in the lower. They are 3/4" adjustable shelves with 1 1/2" frame stock front edge.
- One fixed shelf and center rail at 34 1/2" above floor.
- Finish interior
- Flush toe kick bottom rail
- Straight valance top rail, specify if other valance design is desired (no upcharge).
- 96" tall ships as illustrated with flush toe and loose sub-toe platform. A finished covering must be applied in the field to the sides of the toe area when it will be exposed.

96" tall	TBU189618	
	TBU219618	
	TBU249618	
	TBU279618	
	TBU309618	
	TBU339618	
	TBU369618	

TALL BOOKCASE UNIT WITH LOWER DOOR(S)

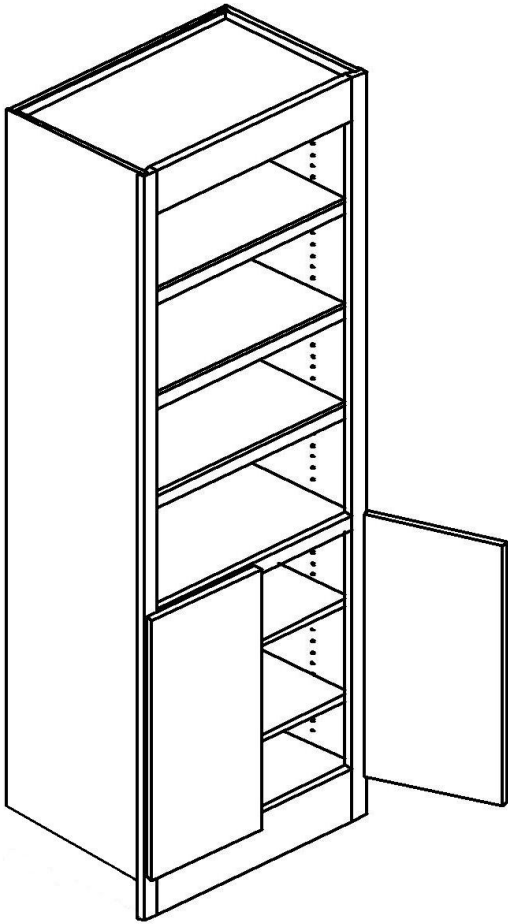

- Standard 13” deep
- One fixed shelf and center rail at 34 1/2” above floor.
- Door(s) over lower opening.
- Door(s) align with standard 34 1/2”H BFD configuration.
- Finished interior throughout.
- Flush toe kick bottom rail.
- Straight valance top rail. Specify if other valance design is desired (no upcharge).
- Lower section will have two 3/4” adjustable shelves.
- 84-85” tall units: two 3/4” adjustable shelves with 1 1/2” frame stock edge in upper, open section.
- Over 85”to 91” tall units: three 3/4” adjustable shelves with 1 1/2” frame stock edge in upper, open section. Sub-toe base ships loose.
- Over 91”to 97” tall units: four 3/4” adjustable shelves with 1 1/2” frame stock edge in upper, open section. Sub-toe base ships loose.
- Illustration depicts any over 84” tall which ship with flush toe and loose sub-toe platform. A finished covering must be applied in the field to the sides of the toe area when it will be exposed. If 84” tall or less, sub-toe is incorporated into the cabinet.

	PRODUCT CODE	LEVEL 1	LEVEL 2
84” tall	TBUFD1884-1		
	TBUFD2184-1		
	TBUFD2484-1		
	TBUFD2484-2		
	TBUFD2784-2		
	TBUFD3084-2		
	TBUFD3384-2		
	TBUFD3684-2		
90” tall	TBUFD1890-1		
	TBUFD2190-1		
	TBUFD2490-1		
	TBUFD2490-2		
	TBUFD2790-2		
	TBUFD3090-2		
	TBUFD3390-2		
	TBUFD3690-2		
96” tall	TBUFD1896-1		
	TBUFD2196-1		
	TBUFD2496-1		
	TBUFD2496-2		
	TBUFD2796-2		
	TBUFD3096-2		
	TBUFD3396-2		
	TBUFD3696-2		

TALL BOOKCASE UNIT WITH DRAWER AND DOOR(S)

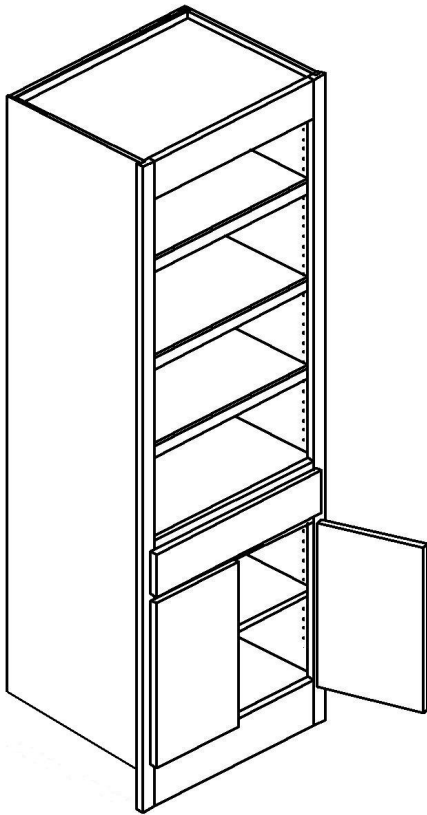

	PRODUCT CODE	LEVEL 1	LEVEL 2
84" tall	TBU1D1884-1		
	TBU1D2184-1		
	TBU1D2484-1		
	TBU1D2484-2		
	TBU1D2784-2		
	TBU1D3084-2		
	TBU1D3384-2		
	TBU1D3684-2		

90" tall	TBU1D1890-1		
	TBU1D2190-1		
	TBU1D2490-1		
	TBU1D2490-2		
	TBU1D2790-2		
	TBU1D3090-2		
	TBU1D3390-2		
	TBU1D3690-2		

- Standard 13" deep
- One fixed shelf and center rail at 34 1/2" above floor.
- 4" drawer box above lower door(s).
- Door(s)/drawer align with standard 34 1/2"H base configuration.
- Finished interior throughout.
- Flush toe kick bottom rail.
- Straight valance top rail. Specify if other valance design is desired (no upcharge).
- Lower section will have one 3/4" adjustable shelf.
- 84-85" tall units: two 3/4" adjustable shelves with 1 1/2" frame stock edge in upper, open section.
- Over 85" to 91" tall units: three 3/4" adjustable shelves with 1 1/2" frame stock edge in upper, open section. Sub-toe base ships loose.
- Over 91" to 97" tall units: four 3/4" adjustable shelves with 1 1/2" frame stock edge in upper, open section. Sub-toe base ships loose.
- Illustration depicts any over 84" tall which ship with flush toe and loose sub-toe platform. A finished covering must be applied in the field to the sides of the toe area when it will be exposed. If 84" tall or less, sub-toe is incorporated into the cabinet.

96" tall	TBU1D1896-1		
	TBU1D2196-1		
	TBU1D2496-1		
	TBU1D2496-2		
	TBU1D2796-2		
	TBU1D3096-2		
	TBU1D3396-2		
	TBU1D3696-2		

NOTE: Blumotion glides are not available on cabinets less than 12" deep. If depth is reduced below 12", other glides will be substituted.

TALL BOOKCASE UNIT WITH DOOR(S) AND DRAWER AT BOTTOM
(INVERTED CONFIGURATION)

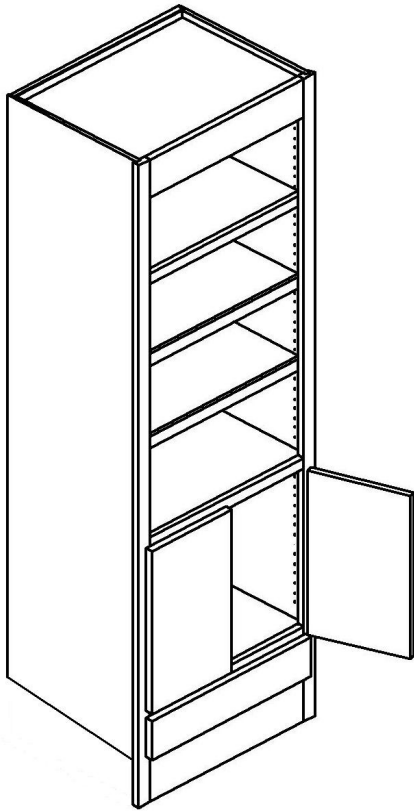

- Standard 13” deep
- One fixed shelf and center rail at 34 1/2” above floor.
- 4” drawer box below door(s).
- Door(s)/drawer align with standard 34 1/2”H inverted base configuration.
- Finished interior throughout.
- Flush toe kick bottom rail.
- Straight valance top rail. Specify if other valance design is desired (no upcharge).
- Fixed floor between door area and drawer box.
- Lower section will have one 3/4” adjustable shelf.
- 84-85” tall units: two 3/4” adjustable shelves with 1 1/2” frame stock edge in upper, open section.
- Over 85” to 91” tall units: three 3/4” adjustable shelves with 1 1/2” frame stock edge in upper, open section. Sub-toe base ships loose.
- Over 91” to 97” tall units: four 3/4” adjustable shelves with 1 1/2” frame stock edge in upper, open section. Sub-toe base ships loose.
- Illustration depicts any over 84” tall which ship with flush toe and loose sub-toe platform. A finished covering must be applied in the field to the sides of the toe area when it will be exposed. If 84” tall or less, sub-toe is incorporated into the cabinet.

	PRODUCT CODE	LEVEL 1	LEVEL 2
84” tall	TBUI1884-1		
	TBUI2184-1		
	TBUI2484-1		
	TBUI2484-2		
	TBUI2784-2		
	TBUI3084-2		
	TBUI3384-2		
	TBUI3684-2		
90” tall	TBUI1890-1		
	TBUI2190-1		
	TBUI2490-1		
	TBUI2490-2		
	TBUI2790-2		
	TBUI3090-2		
	TBUI3390-2		
96” tall	TBUI1896-1		
	TBUI2196-1		
	TBUI2496-1		
	TBUI2496-2		
	TBUI2796-2		
	TBUI3096-2		
	TBUI3396-2		
	TBUI3696-2		

NOTE: Blumotion glides are not available on cabinets less than 12” deep. If depth is reduced below 12”, other glides will be substituted.

TALL DIAGONAL BOOKCASE UNITS

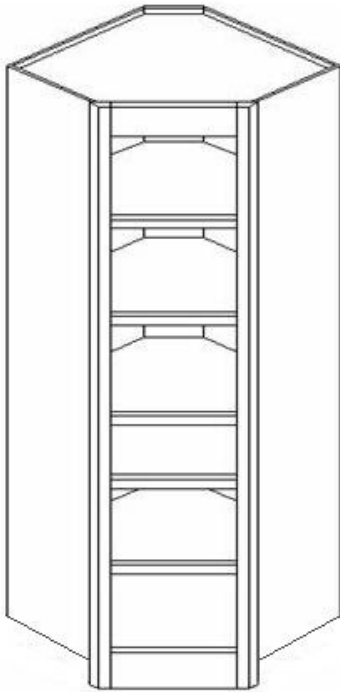

	PRODUCT CODE	LIST
	13" deep	
84" tall	TDBU248424	
90" tall	TDBU249024	
96" tall	TDBU249624	
	16" deep	
84" tall	TDBU278427	
90" tall	TDBU279027	
96" tall	TDBU279627	

- Standard 13" deep / 24" wide or 16" deep / 27" wide
- One fixed shelf and center rail at 34 1/2" above floor.
- Finished interior throughout.
- Flush toe kick bottom rail.
- Straight valance top rail. Specify if other valance design is desired (no upcharge).
- Lower section will have two 3/4" adjustable shelves with 1 1/2" frame stock edge.
- 84-85" tall units: two 3/4" adjustable shelves with 1 1/2" frame stock edge in upper, open section.
- Over 85" to 91" tall units: three 3/4" adjustable shelves with 1 1/2" frame stock edge in upper, open section. Sub-toe base ships loose.
- Over 91" to 97" tall units: four 3/4" adjustable shelves with 1 1/2" frame stock edge in upper, open section. Sub-toe base ships loose.
- Illustration depicts any over 84" tall which ship with flush toe and loose sub-toe platform. A finished covering must be applied in the field to the sides of the toe area when it will be exposed. If 84" tall or less, sub-toe is incorporated into the cabinet.
- Doors can be added with an upcharge.



NOTES



NOTES



NOTES

4 DRAWER DRESSER UNIT



	PRODUCT CODE	LEVEL 1	LEVEL 2
36" tall	DU4D3036		
	DU4D3636		
	DU4D4236		
42" tall	DU4D3042		
	DU4D3642		
	DU4D4242		
48" tall	DU4D3048		
	DU4D3648		
	DU4D4248		
54" tall	DU4D3054		
	DU4D3654		
	DU4D4254		

4 DRAWER DRESSER UNIT

- Built with 1 1/2" wood top and Crown A trim.
- One small top drawer and three large drawers.
- Specify choice of Bun feet, French legs or Tapered legs.
- Standard 21" deep.
- Finished sides
- This unit must be attached to the wall to prevent it from tipping over.

BASE NIGHT STANDS

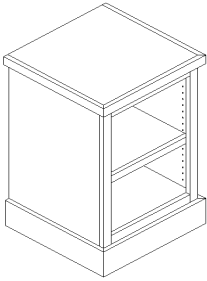

BASE NIGHT STAND OPEN

- Flush finish left and right standard.
- 30 1/2" tall night stand with finished interior.
- One full depth adjustable shelf with frame stock added to front edge.
- Flush toe with ABM3 applied.
- 1 1/2" wood top

	PRODUCT CODE	LEVEL 1	LEVEL 2
18" deep	BNS1518		N/A
	BNS1818		N/A
	BNS2118		N/A
21" deep	BNS1521		N/A
	BNS1821		N/A
	BNS2121		N/A

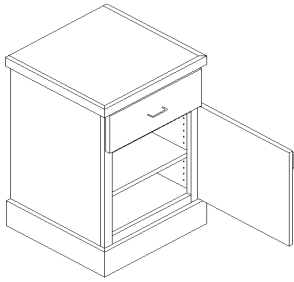

BASE NIGHT STAND, DOOR AND DRAWER

- Flush finish left and right standard
- 30 1/2" tall night stand with finished interior.
- One full depth adjustable shelf for 18" deep night stands.
- One 3/4 depth adjustable shelf for 21" deep night stands.
- Flush toe with ABM-3 applied
- 1 1/2" wood top

18" deep	BNS1D1518		
	BNS1D1818		
	BNS1D2118		
21" deep	BNS1D1521		
	BNS1D1821		
	BNS1D2121		

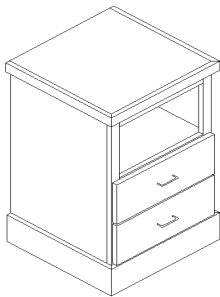

BASE NIGHT STAND, TWO DRAWERS

- Flush finish left and right standard
- 30 1/2" Tall night stand with finished interior.
- Two equal height drawers with opening above drawers.
- Flush toe with ABM-3 applied.
- 1 1/2" wood top

18" deep	BNS2D1518		
	BNS2D1818		
	BNS2D2118		
21" deep	BNS2D1521		
	BNS2D1821		
	BNS2D2121		

BASE WINDOW SEATS

BASE WINDOW SEAT CABINETS

16 1/2" high, 24" deep

Offered in 4 versions: two full height doors (BWSFD), one 8" high drawer (BWS1D), two side-by-side 8" high drawers (BWS2D), and open to the floor (BWSOPEN).

Flush toe except for BWSOPEN.

No top is included, WTOP can be purchased separately.

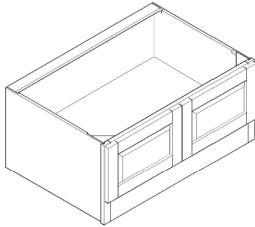

BASE WINDOW SEAT WITH FULL HEIGHT DOORS

two full height doors (BWSFD)

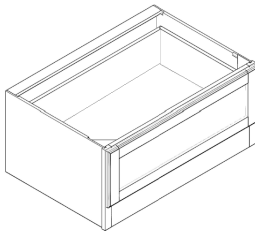

BASE WINDOW SEAT WITH ONE DRAWER

one 8" high drawer (BWS1D)

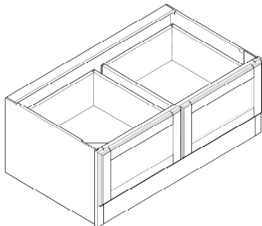

BASE WINDOW SEAT WITH TWO DRAWERS

two side-by-side 8" high drawers (BWS2D)

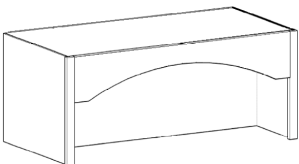

BASE WINDOW SEAT OPEN

open to the floor (BWSOPEN)

PRODUCT CODE	LEVEL 1	LEVEL 2
BWSFD24		
BWSFD27		
BWSFD30		
BWSFD33		
BWSFD36		
BWSFD39		
BWSFD42		
BWS1D24		
BWS1D27		
BWS1D30		
BWS1D33		
BWS1D36		
BWS1D39		
BWS1D42		
BWS2D36		
BWS2D39		
BWS2D42		
BWS2D45		
BWS2D48		
BWSOPEN36		N/A
BWSOPEN39		N/A
BWSOPEN42		N/A
BWSOPEN45		N/A
BWSOPEN48		N/A

- BWSOPEN has no cabinet bottom and is open to the floor.
- Standard with 6" arched valance top rail
- Finished interior matching to specie /finish.
- Interior useable space is 13" only from front to back due to a fixed center partition that spans the width and is necessary for support.
- No finished top is included, WTOP can be purchased separately.

MANTLE SHELF

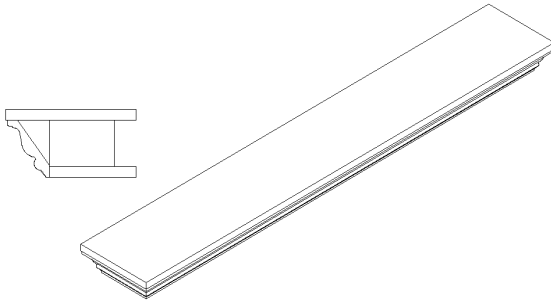

PRODUCT CODE	LIST PRICE
MNTLSH	per Linear Foot

MANTLE SHELF

- Includes mounting plate
- 9" deep X 4 5/8" tall X specified length.
- Crown 6 placed around 3 sides.

HUTCH

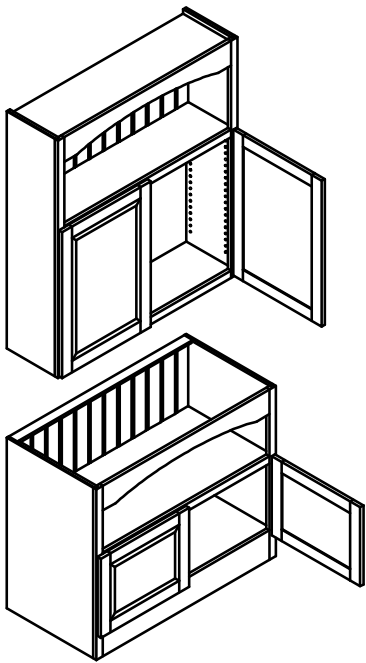

- 1 1/2" wood top between upper and lower section
- 13" deep upper section
- Top, open section is equivalent to 18" high cabinet
- 21" deep, 34 1/2" high lower section
- Both ends finished
- Finished interior, flush toe, and arched valance rails standard

	PRODUCT CODE	LEVEL 1	LEVEL 2
84" high	THTC2484		
	Two adjustable shelves in upper	THTC2784	
		THTC3084	
	THTC3384		
	THTC3684		
	THTC3984		
THTC4284			
90" high	THTC2490		
	Three adjustable shelves in upper	THTC2790	
		THTC3090	
	THTC3390		
	THTC3690		
	THTC3990		
THTC4290			
96" high	THTC2496		
	Three adjustable shelves in upper	THTC2796	
		THTC3096	
	THTC3396		
	THTC3696		
	THTC3996		
THTC4296			

FLAT FIRE PLACE UNITS
****NOT AVAILABLE IN RED BIRCH****

FLAT FIRE PLACE UNIT #1

- Apply finish and species charges as necessary.
- Specify choice of large rope, large dentil, or large egg and dart moldings below mantle, see example.
- Specify choice of appliqué: Shell, Grape, Acanthus, etc.
- Specify overall height and width.
- Specify height and width of opening.
- Overall height must be at least 20 1/4" more than opening height.
- Overall width must be at least 14" more than opening width, each column leg can be no less than 7" wide.
- Depth is 5 3/4" at bottom, 7 7/8" at the top with molding extension.
- Columns standard with flutes and rosettes.
- Large crown with insert will be shipped loose.
- Not available in Red Birch or Red Grandis.

PRODUCT CODE	LIST
FFPU1	

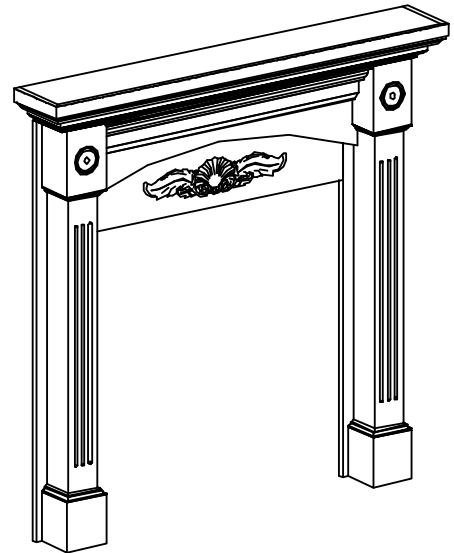
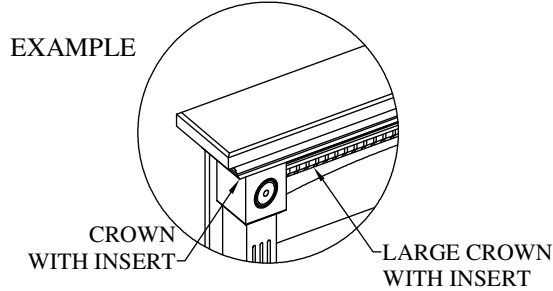

FLAT FIRE PLACE UNIT #2

- Apply finish and species charges as necessary.
- Specify choice of large rope, large dentil, or large egg and dart moldings below mantle, see example.
- Specify overall height and width.
- Specify height and width of opening.
- Overall height must be at least 20 1/4" more than opening height.
- Overall width must be at least 14" more than opening width, each column leg can be no less than 7" wide.
- Depth is 5 3/4" at bottom, 7 7/8" at the top with molding extension.
- Columns standard with flutes and rosettes.
- Large crown with insert will be shipped loose.
- Not available in Red Birch or Red Grandis.

PRODUCT CODE	LIST
FFPU2	

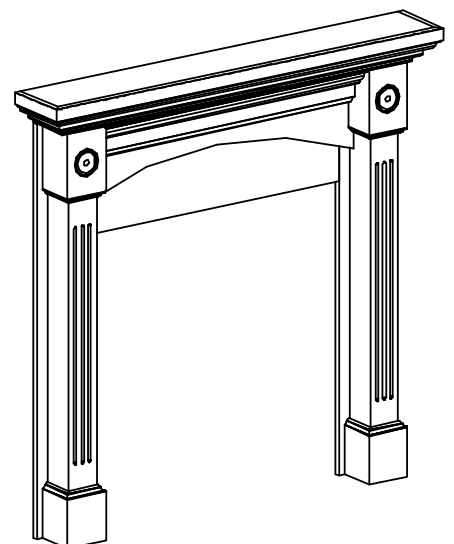
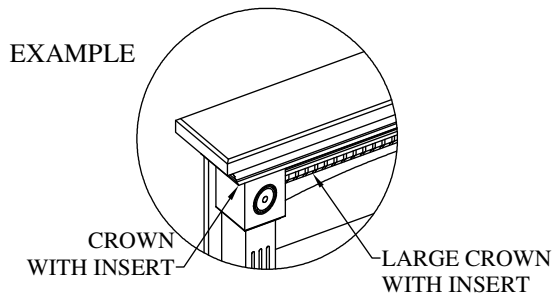

CORNER FIREPLACE
****NOT AVAILABLE IN RED BIRCH****

****Please ensure that your specific fireplace insert will fit in the unit with the dimensions specified.****
****Satisfaction of local and state building and fire code is YOUR responsibility.****

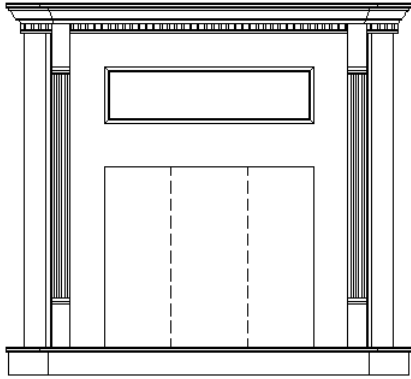

PRODUCT CODE	LIST
CFPU	

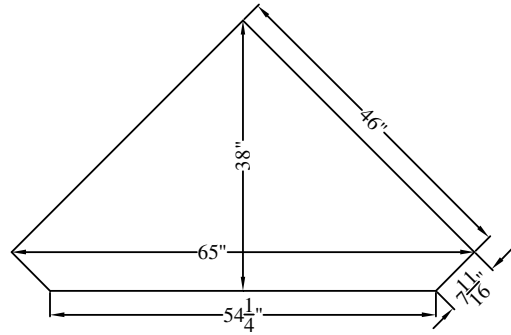

TOP VIEW

- Apply finish and species charges as necessary.
- Overall height is 59 3/4 inches including moldings.
- Specify opening height and width
- Max opening height is 37 in.
- Max opening width is 40 1/2 in.
- The front panel above opening flips down to reveal a hidden storage area.
- Columns standard with flutes
- Not available in Red Birch or Red Grandis.

RESIDENTIAL ACCESSORIES / MODIFICATIONS

BASE MINI FILLER

- 3/4" solid wood frame stock
- Standard widths of 3" and 6"
- Standard ships finished on face and all four 3/4" edges.
- Fillers are shipped at the size indicated in the product nomenclature and are not cut down at the factory except by special request only.



PRODUCT CODE	LIST
BMF324.5	
BMF329	
BMF624.5	
BMF629	

BASE MINI OVERLAY FILLER STRIP

- Overlay only, does not include filler
- All four edges will be profiled to match door edges.
- Length will match height of door/drawer overlay.
- Finished on face and all four 3/4" edges.
- Madrid, Sardinia, and Valletta overlays cannot be any smaller than 2 7/8" wide.
- When adding flutes:
 - 2 flutes are standard on BOFS3 (2 3/4" wide)
 - 5 flutes are standard on BOFS6 (5 3/4" wide)



2 3/4" wide	BMOFS3
5 3/4" wide	BMOFS6

OTHER RESIDENTIAL ACCESSORIES & MODIFICATIONS

- Please see Modifications and Accessories in the Base section as needed for Base-Mini and File Cabinets and Dresser units.
- Please see Modifications and Accessories in the Base section as needed for Base Bookcase Cabinets.
- Please see Modifications and Accessories in the Wall section as needed for Wall Bookcase Cabinets.
- Please see Modifications and Accessories in the Tall section as needed for Tall Bookcase Cabinets.



NOTES